

Article number: 20940630A

Description: E+G Clamping bolt
GN 802-M6-52

Measures

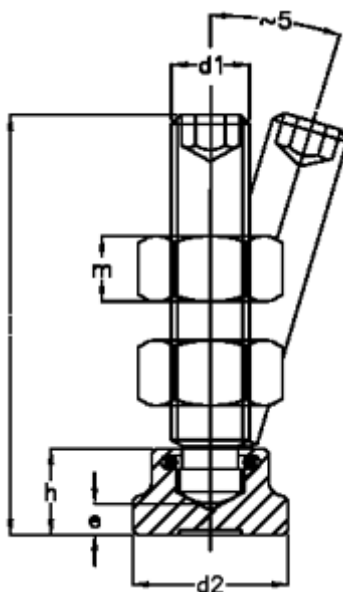

d1 = M6

d2 = 12

e = 2,2

h = 7

l1 = 52

m = 5.2